

LUXEON Rebel
Automotive Specification

*Optimized solutions for
automotive applications*

Technical Datasheet DS58

LUXEON
NEVER BEFORE POSSIBLE



LUXEON[®] Rebel

Automotive Specification

Introduction

Automotive Specification LUXEON[®] Rebel LEDs are specifically designed and tested to meet and exceed expectations for reliability, performance and lifetime in all vehicle applications. Philips Lumileds automotive color binning structure meets both SAE and ECE color specifications and provides finer granularity than existing systems. PPAP documentation is available upon request. Automotive Specification LUXEON Rebel LEDs are superior LED products for:

- Daytime Running Lights (DRL)
- Turn Lamps
- Stop/Tail Lamps
- Position Lamps
- Backup Lamps
- Side Marker Lamps
- Rear Fog Lamps
- Interior Lamps.

PHILIPS
LUMILEDS

Table of Contents

Product Nomenclature.....	3
Average Lumen Maintenance Characteristics	3
Environmental Compliance.....	3
Flux Characteristics.....	4
Optical Characteristics.....	5
Electrical Characteristics.....	6
Absolute Maximum Ratings.....	8
Absolute Minimum Ratings.....	8
JEDEC Moisture Sensitivity	9
Reflow Soldering Characteristics.....	10
Mechanical Dimensions	11
Pad Configuration	12
Solder Pad Design.....	12
Wavelength Characteristics.....	13
Typical Light Output Characteristics over Temperature.....	15
Typical Forward Current Characteristics.....	17
Typical Relative Luminous Flux	19
Current Derating Curves.....	21
Typical Radiation Patterns.....	25
Emitter Pocket Tape Packaging.....	28
Emitter Reel Packaging	29
Automotive Product Binning and Labeling.....	30
LUXEON Rebel PC Amber Color Bin Structure.....	35
Forward Voltage Bins.....	37

Product Nomenclature

LUXEON Rebel is tested and binned at 350 mA.

The part number designation is explained as follows:

L X M A - A B C D - E F G H

Where:

A — designates radiation pattern (value P for Lambertian)

B — designates color variant (W for Automotive White, L for Amber and PC Amber, H for Red-Orange)

C — designates color variant (0 for Automotive White, Amber, PC Amber, and Red-Orange)

D — designates technology (1 for Automotive White, Amber, Red-Orange standard flux direct color; 2 for PC Amber Phosphor-Converted and Red-Orange high flux direct color)

E — reserved for future product offerings

FGH — minimum luminous flux (lm) performance

Products tested and binned at 350 mA follow the part numbering scheme:

L X M A - P x 0 x - x x x x

Average Lumen Maintenance Characteristics

Lifetime for solid-state lighting devices (LEDs) is typically defined in terms of lumen maintenance—the percentage of initial light output remaining after a specified period of time.

Philips Lumileds projects that LUXEON Rebel Automotive White products will deliver, on average, 70% lumen maintenance at 50,000 hours of operation at a forward current of 350 mA at 100% duty cycle. This projection is based on constant current operation with junction temperature maintained at or below 135°C.

Philips Lumileds projects that red-orange and amber LUXEON Rebel products will deliver, on average, 70% lumen maintenance at 30,000 hours of operation at a forward current of 350 mA at 100% duty cycle. This projection is based on constant current operation with junction temperature maintained at or below 125°C.

Philips Lumileds projects that PC Amber LUXEON Rebel products will deliver, on average, 70% lumen maintenance at 5,600 hours of operation at a forward current of 350 mA at 100% duty cycle. This projection is based on constant current operation with junction temperature maintained at or below 135°C.

This performance is based on independent test data, Philips Lumileds historical data from tests run on similar material systems, and internal LUXEON reliability testing. Observation of design limits included in this data sheet is required in order to achieve this projected lumen maintenance.

Environmental Compliance

Philips Lumileds is committed to providing environmentally friendly products to the solid-state lighting market. The LUXEON Rebel is compliant to the European Union directives on the restriction of hazardous substances in electronic equipment, namely the REACH, ELV, and RoHS directives.

Philips Lumileds will not intentionally add the following restricted materials to the LUXEON Rebel: lead, mercury, cadmium, hexavalent chromium, polybrominated biphenyls (PBB) or polybrominated diphenyl ethers (PBDE).

Flux Characteristics

Flux Characteristics for LUXEON Rebel Junction Temperature, $T_j = 25^\circ\text{C}$ [4]

Table 1.

Performance at Test Current				Typical Performance at Indicated Current	
Color	Part Number [5]	Minimum Luminous Flux (lm) Φ_v [1] [3]	Test Current (mA)	Typical Luminous Flux (lm) Φ_v [2] [3]	Drive Current (mA)
Automotive White	LXMA-PW01-0100	100	350	180	700
	LXMA-PW01-0110	110	350	195	700
Red-Orange	LXMA-PH01-0040	40	350	75	700
	LXMA-PH01-0050	50	350	85	700
	LXMA-PH02-0060	60	350	122	700
	LXMA-PH02-0070	70	350	134	700
Amber	LXMA-PL01-0023	23.5	350	45	700
	LXMA-PL01-0030	30	350	60	700
	LXMA-PL01-0040	40	350	70	700
PC Amber	LXMA-PL02-0080	80	350	145	700
	LXMA-PL02-0090	90	350	165	700
	LXMA-PL02-0100	100	350	180	700

Notes for Table 1:

1. Minimum luminous flux performance guaranteed within published operating conditions. Philips Lumileds maintains a tolerance of $\pm 6.5\%$ on flux measurements.
2. Typical luminous flux or radiometric power performance when device is operated within published operating conditions.
3. LUXEON Rebel products with even higher luminous flux and radiometric power levels will become available in the future. Please consult Philips Lumileds for more information.
4. Junction Temperature is estimated based on instant measurement at thermal pad temperature of 25°C .
5. Please contact Philips Lumileds for information on custom part numbers.

Optical Characteristics

Lambertian LUXEON Rebel at Test Current ^[1] Junction Temperature, $T_j = 25^\circ\text{C}$ ^[10]

Table 2.

Color	Color Temperature ^{[2],[3]} CCT			Typical Spectral Half-width ^[5] (nm) $\Delta\lambda_{1/2}$	Typical Temperature Coefficient of Dominant Wavelength (nm/°C) $\Delta\lambda_D / \Delta T_j$	Typical Total Included Angle ^[6] (degrees) $\theta_{0.90V}$	Typical Viewing Angle ^[7] (degrees) $2\theta_{1/2}$
	Min.	Typ.	Max.				
Automotive White ^[8]	3800 K	5500 K	6300 K	—	—	160	120
Red-Orange ^[9]	610.0 nm	617.0 nm	620.0 nm	20	0.08	160	125
Amber ^[9]	587.0 nm	590.0 nm	592.0 nm	14	0.10	160	125
PC Amber ^[8]	588.0 nm	591.0 nm	592.0 nm	80	0.10	160	120

Notes for Table 2:

- LUXEON Rebel is tested and binned at 350 mA.
- Dominant wavelength is derived from the CIE 1931 Chromaticity diagram and represents the perceived color. Philips Lumileds maintains a tolerance of ± 0.5 nm for dominant wavelength measurements.
- CCT $\pm 5\%$ tester tolerance.
- CRI (Color Rendering Index) for white product types is 70 typical.
- Spectral width at $1/2$ of the peak intensity.
- Total angle at which 90% of total luminous flux is captured.
- Viewing angle is the off axis angle from lamp centerline where the luminous intensity is $1/2$ of the peak value.
- All white and PC Amber products are built with Indium Gallium Nitride (InGaN).
- All red-orange and amber products are built with Aluminum Indium Gallium Phosphide (AlInGaP).
- Junction Temperature is estimated based on instant measurement at thermal pad temperature of 25°C .

Electrical Characteristics

Electrical Characteristics at 350 mA for LUXEON Rebel, Junction Temperature, $T_j = 25^\circ\text{C}$

Table 3.

Color	Forward Voltage V_f ^[1]			Typical Dynamic Resistance ^[4] (Ω) R_D	Typical Temperature Coefficient of Forward Voltage ^[2] ($\text{mV}/^\circ\text{C}$) $\Delta V_f / \Delta T_j$	Typical Thermal Resistance Junction to Thermal Pad ($^\circ\text{C}/\text{W}$) ^[3] $R\theta_{j-c}$
	Min.	Typ.	Max.			
LXMA-PW01-0100	2.55	2.92	3.27	.03	-2.0 to -4.0	10
LXMA-PW01-0110	2.55	2.92	3.27	.03	-2.0 to -4.0	10
LXMA-PH01-0040	2.31	2.9	3.51	1.5	-2.0 to -4.0	12
LXMA-PH01-0050	2.31	2.9	3.51	1.5	-2.0 to -4.0	12
LXMA-PH02-0060	1.80	2.10	2.80	0.57	-2.0 to -4.0	8
LXMA-PH02-0070	1.80	2.10	2.80	0.57	-2.0 to -4.0	8
LXMA-PL01-0023	2.31	2.9	3.51	1.3	-2.0 to -4.0	12
LXMA-PL01-0030	2.31	2.9	3.51	1.3	-2.0 to -4.0	12
LXMA-PL01-0040	2.31	2.9	3.51	1.3	-2.0 to -4.0	12
LXMA-PL02-0080	2.55	2.92	3.27	0.36	-2.0 to -4.0	10
LXMA-PL02-0090	2.55	2.92	3.27	0.36	-2.0 to -4.0	10
LXMA-PL02-0100	2.55	2.92	3.27	0.36	-2.0 to -4.0	10

Notes for Table 3:

1. Philips Lumileds maintains a tolerance of $\pm 0.06\text{V}$ on forward voltage measurements.
2. Measured between $25^\circ\text{C} = T_j = 110^\circ\text{C}$ at $I_f = 350\text{ mA}$.
3. Does not include wall plug efficiency.
4. Dynamic resistance is the inverse of the slop in the linear forward voltage model for LEDs. See Forward Voltage vs. Forward Current curves.

Electrical Characteristics

Typical Electrical Characteristics at 700 mA for LUXEON Rebel, Junction Temperature, $T_j = 25^\circ\text{C}$

Table 4.

Color	Typical Forward Voltage V_f [1] (V)
LXMA-PW01-0100	3.06
LXMA-PW01-0110	3.06
LXMA-PH01-0040	3.60
LXMA-PH01-0050	3.60
LXMA-PH02-0060	2.30
LXMA-PH02-0070	2.30
LXMA-PL01-0023	3.60
LXMA-PL01-0030	3.60
LXMA-PL01-0040	3.60
LXMA-PL02-0080	3.06
LXMA-PL02-0090	3.06
LXMA-PL02-0100	3.06

Note for Table 4:

1. Philips Lumileds maintains a tolerance of $\pm 0.06\text{V}$ on forward voltage measurements.

Absolute Maximum Ratings

Table 5a.

Parameter	Automotive White	Red-Orange / Amber	PC Amber
DC Forward Current (mA)	700	700	700
Peak Pulsed Forward Current (mA)	1000	700	700
Average Forward Current (mA)	700	700	700
ESD Sensitivity ^[5]	8kV HBM, 400V MM	8kV HBM, 400V MM	8kV HBM, 400V MM
LED Junction Temperature ^{[1][3][4]}	150°C	135°C	135°C
Operating Case Temperature ^[4]	-40°C - 150°C	-40°C - 135°C	-40°C - 135°C
Storage Temperature	-40°C - 135°C	-40°C - 135°C	-40°C - 135°C
Soldering Temperature	JEDEC 020c 260°C	JEDEC 020c 260°C	JEDEC 020c 260°C
Allowable Reflow Cycles	3	3	3
Autoclave Conditions	121°C at 2 ATM 100% Relative Humidity for 96 Hours Maximum		
Reverse Voltage (Vr)	See Note 2	See Note 2	See Note 2

Notes for Table 5:

1. Proper current derating must be observed to maintain junction temperature below the maximum.
2. LUXEON Rebel LEDs are not designed to be driven in reverse bias.
3. LUXEON Rebel Automotive LEDs driven at maximum LED junction temperature will have limited lifetime.
4. Please consult with Philips Lumileds for more information on maximum time durations and forward currents for these temperature ranges.
5. Measured using human body model and machine model (per AEC-Q101C).

Absolute Minimum Ratings

Table 5b.

Parameter	Automotive White	Red-Orange / Amber	PC Amber
DC Forward Current (mA)	50	50	50

JEDEC Moisture Sensitivity

Table 6.

Level	Floor Life		Soak Requirements	
	Time	Conditions	Standard	
			Time	Conditions
I	unlimited	≤ 30°C / 85% RH	168h + 5 / -0	85°C / 85% RH

Reflow Soldering Characteristics

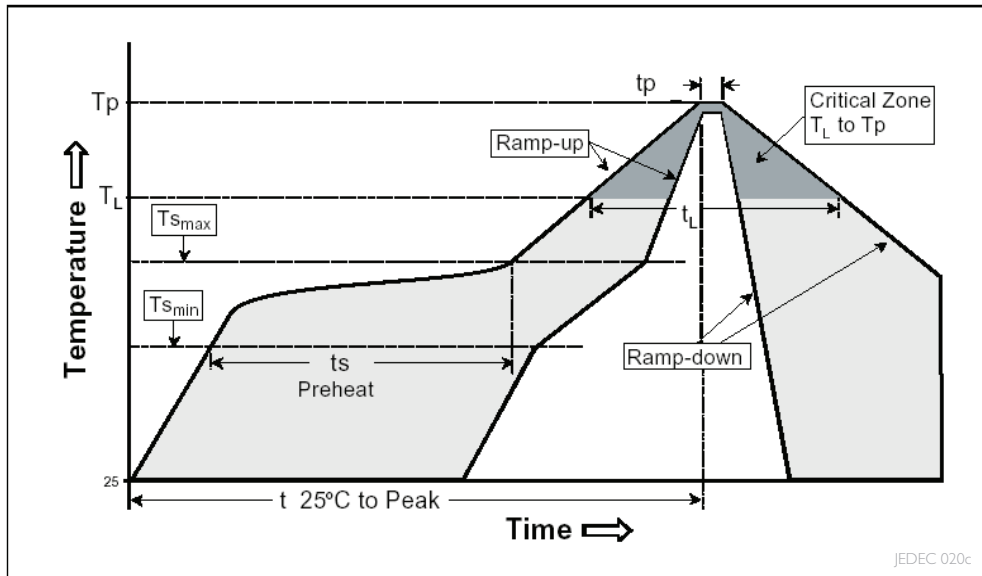

Temperature Profile for Table 7.

Table 7.

Profile Feature	Lead Free Assembly
Average Ramp-Up Rate ($T_{s_{max}}$ to T_p)	3°C / second max
Preheat Temperature Min ($T_{s_{min}}$)	150°C
Preheat Temperature Max ($T_{s_{max}}$)	200°C
Preheat Time ($t_{s_{min}}$ to $t_{s_{max}}$)	60 - 180 seconds
Temperature (T_l)	217°C
Time Maintained Above Temperature T_l (t_l)	60 - 150 seconds
Peak / Classification Temperature (T_p)	260°C
Time Within 5°C of Actual Peak Temperature (t_p)	20 - 40 seconds
Ramp - Down Rate	6°C / second max
Time 25°C to Peak Temperature	8 minutes max

Note for Table 7:

- I. All temperatures refer to the application Printed Circuit Board (PCB), measured on the surface adjacent to the package body.

Mechanical Dimensions

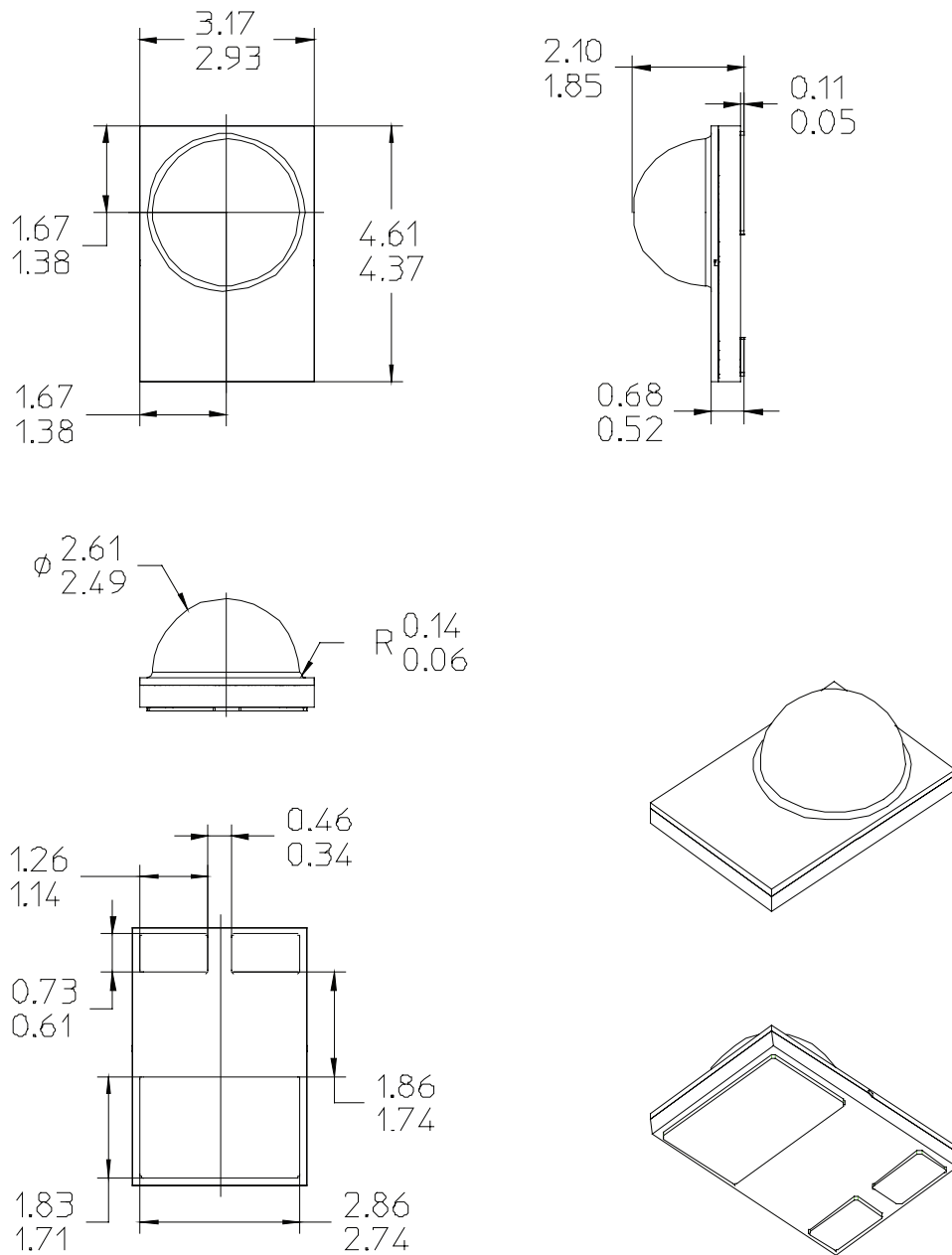

Figure 1. Package outline drawing.

Notes for Figure 1:

1. Do not handle the device by the lens—care must be taken to avoid damage to the lens or the interior of the device that can be damaged by excessive force to the lens.
2. Drawings not to scale.
3. All dimensions are in millimeters.
4. The Thermal Pad is electrically isolated from the Anode and Cathode contact pads.

Pad Configuration

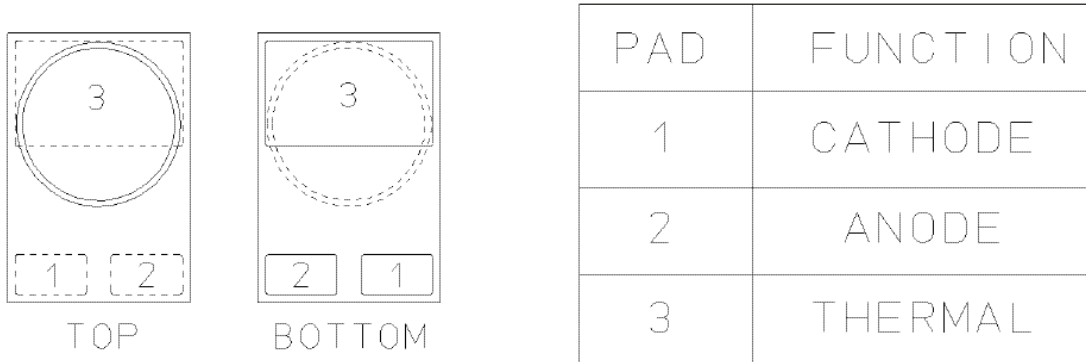

Figure 2. Pad configuration.

Note for Figure 2:

1. The Thermal Pad is electrically isolated from the Anode and Cathode contact pads.

Solder Pad Design

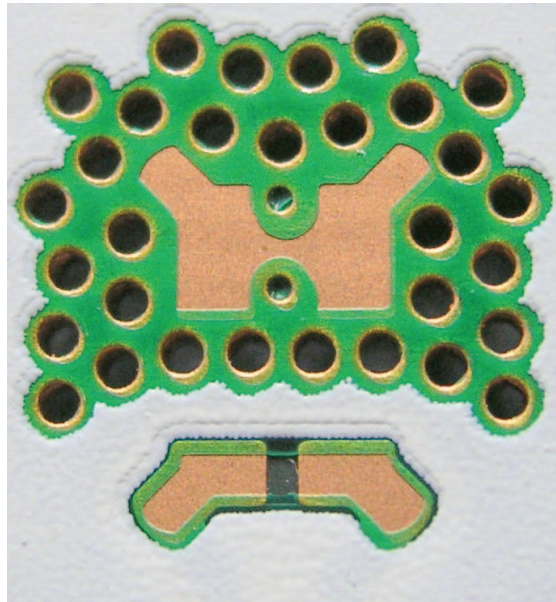

Figure 3. Solder pad layout.

Note for Figure 3:

The photograph shows the recommended LUXEON Rebel layout on Printed Circuit Board (PCB). This design easily achieves a thermal resistance of 7 K/W.

Application Brief AB32 provides extensive details for this layout. In addition, the .dwg files are available at www.philipslumileds.com.

Wavelength Characteristics

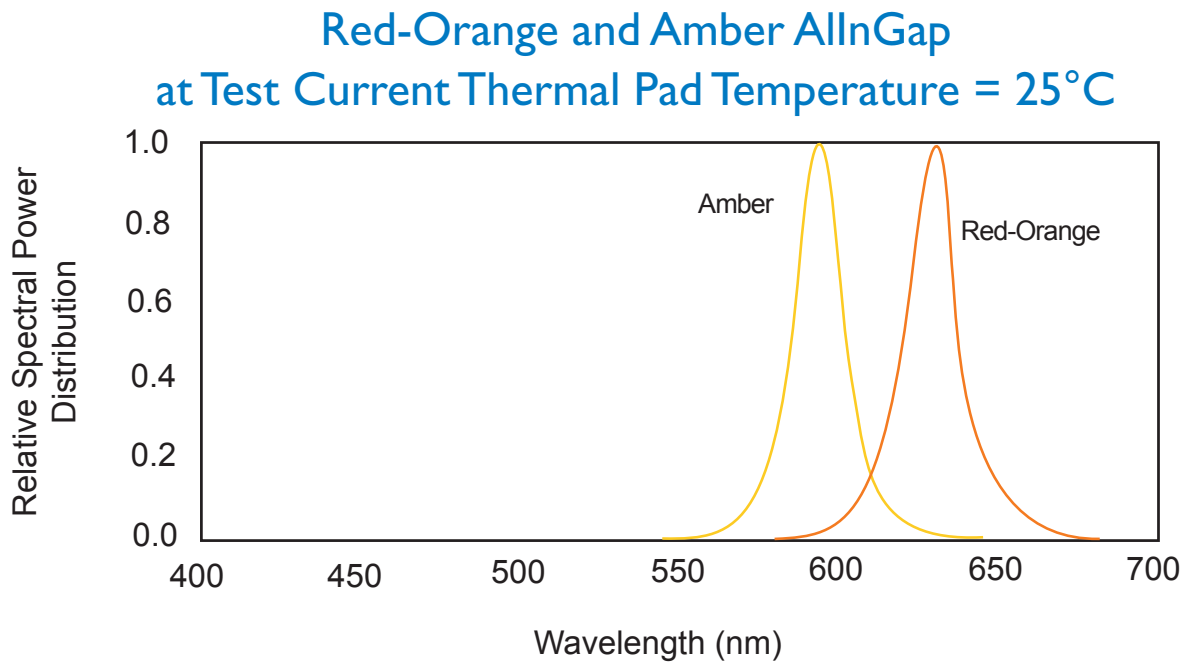

Figure 4. Relative intensity vs. wavelength.

Automotive White, Thermal Pad Temperature = 25°C

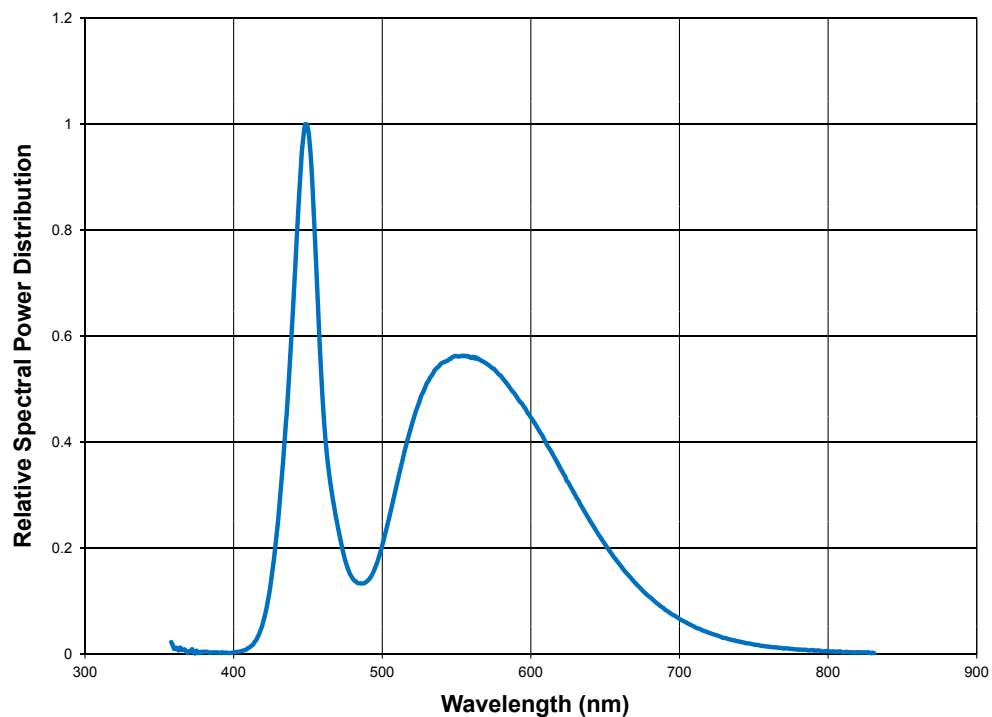

Figure 5. White color spectrum of typical CCT part, integrated measurement.

PC Amber, Thermal Pad Temperature = 25°C

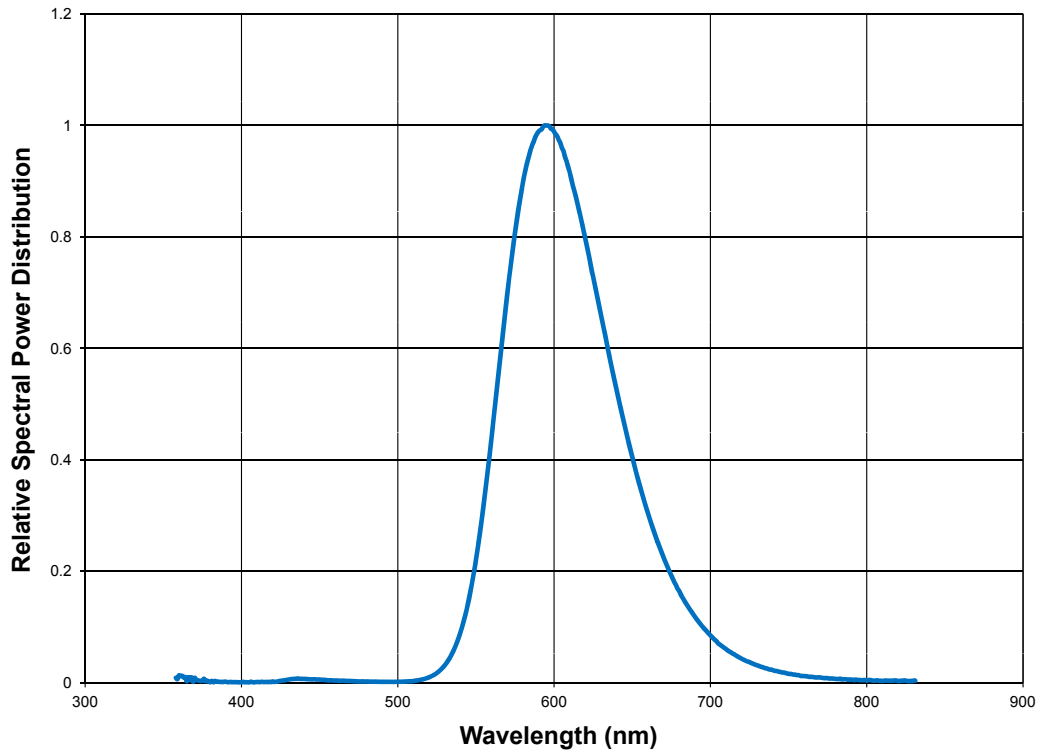

Figure 6. Relative intensity vs. wavelength.

Typical Light Output Characteristics over Temperature

Automotive White at 350 mA and 700 mA Currents

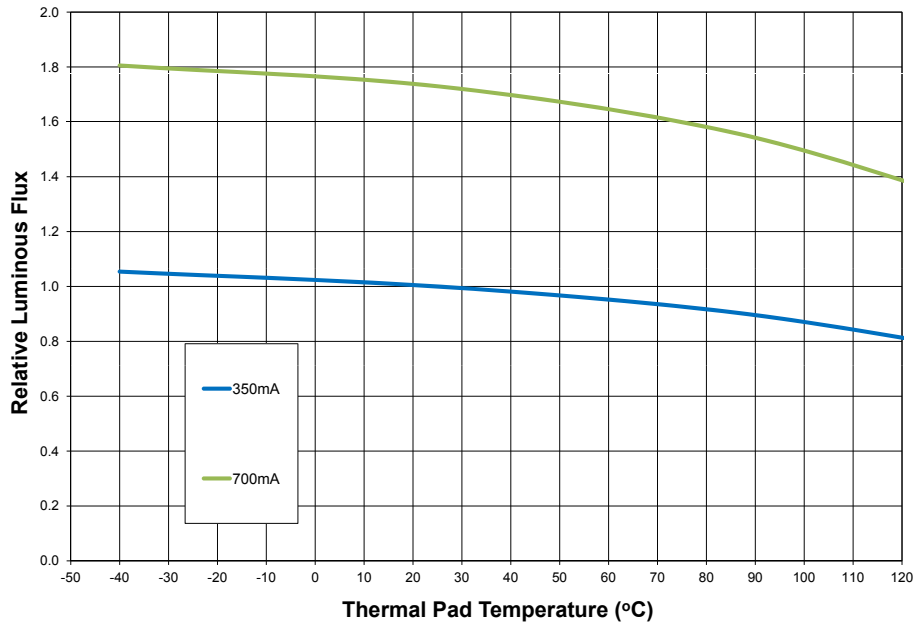

Figure 7. Relative light output vs. thermal pad temperature for Automotive White (Monopulse Measurement, H/C factor is color bin dependent; 5000K to 6300K shown).

PC Amber at 350 mA and 700 mA Currents

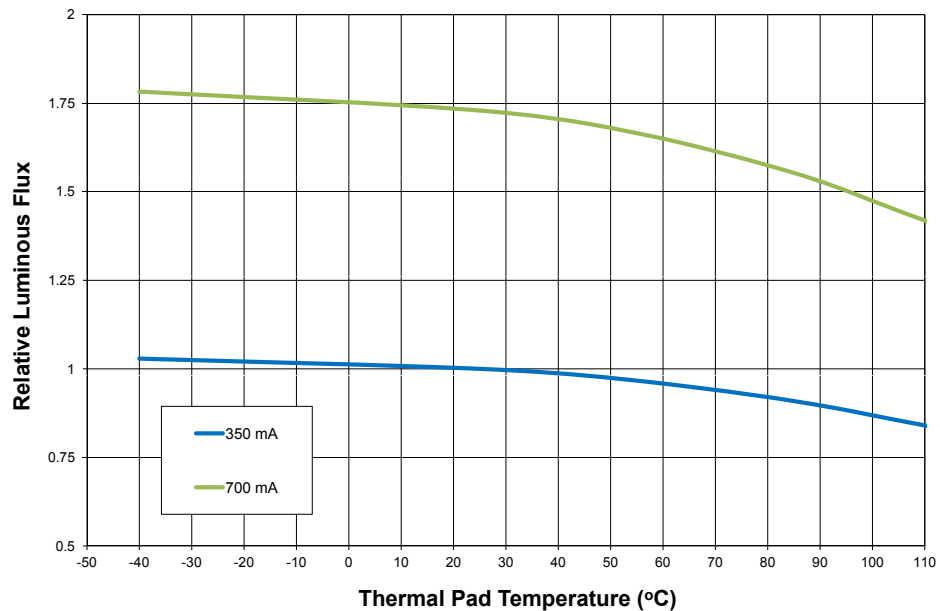

Figure 8. Relative light output vs. thermal pad temperature for PC Amber (Monopulse Measurement).

Red-Orange and Amber AllnGap at 350 mA Current

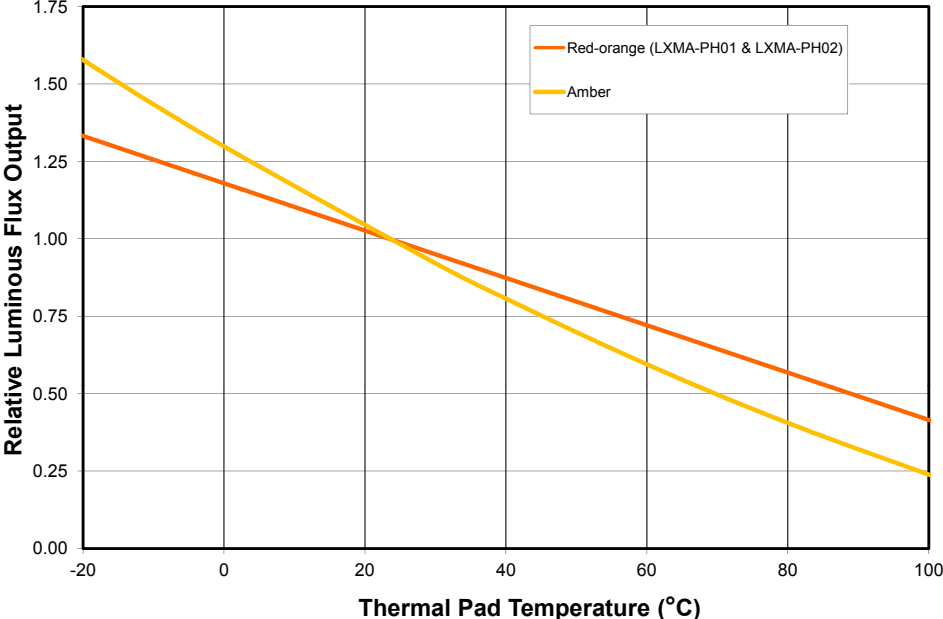

Figure 9. Relative light output vs. thermal pad temperature for Red-Orange and Amber AllnGap at Test Current (Monopulse Measurement).

Typical Forward Current Characteristics

Automotive White, Thermal Pad Temperature = 25°C and 85°C

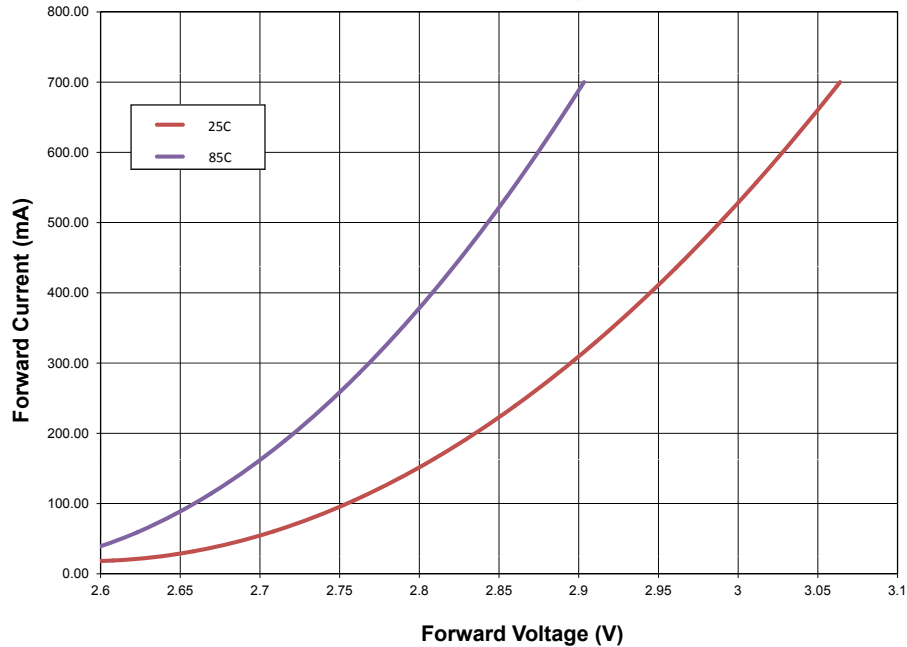

Figure 10. Forward current vs. forward voltage for Automotive White (Monopulse Measurement) at various thermal pad temperatures. [extend to 50 mA]

PC Amber, Thermal Pad Temperature = 25°C and 85°C

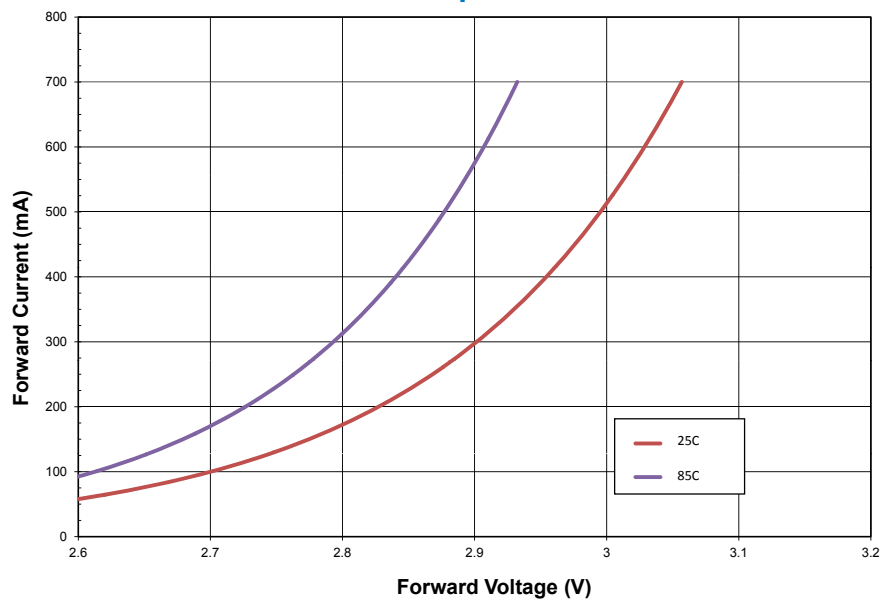

Figure 11. Forward current vs. forward voltage for PC Amber (Monopulse Measurement) at various thermal pad temperatures. [extend to 50 mA]

Notes for Figures 10 & 11:

Driving these high power devices at currents less than the test conditions (350 mA and 700 mA) may produce unpredictable results and may be subject to variation in performance. Pulse width modulation (PWM) is recommended for dimming effects.

Red-Orange and Amber AlInGaP, Thermal Pad Temperature = 25°C

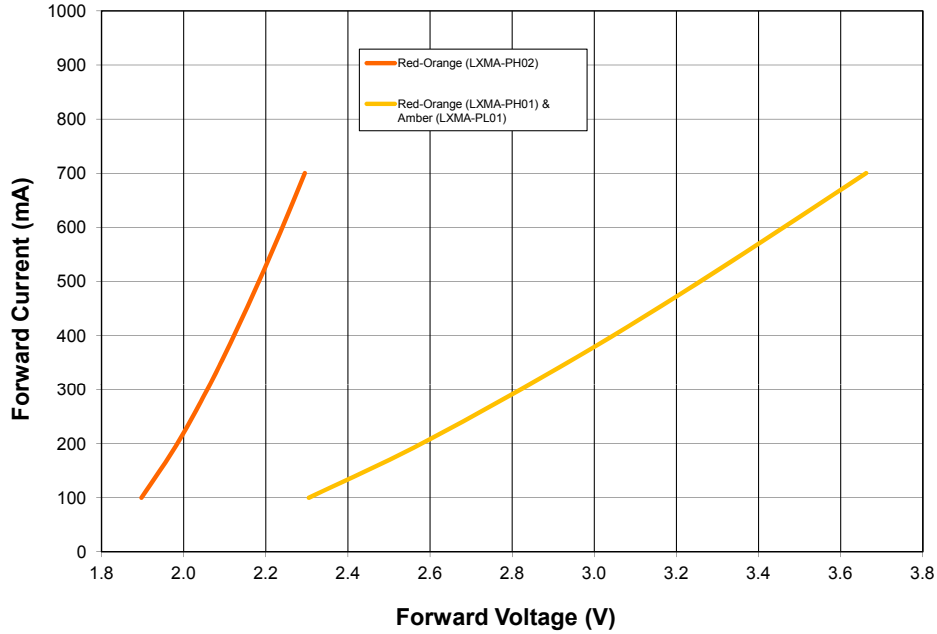

Figure 12. Forward current vs. forward voltage for Red-Orange and Amber AlInGaP (Monopulse Measurement) at 25°C thermal pad temperature.

Note for Figure 12:

Driving these high power devices at currents less than the test conditions (350 mA and 700 mA) may produce unpredictable results and may be subject to variation in performance. Pulse width modulation (PWM) is recommended for dimming effects.

Typical Relative Luminous Flux

Relative Luminous Flux vs. Forward Current for Automotive White, Thermal Pad Temperature = 25°C and 85°C

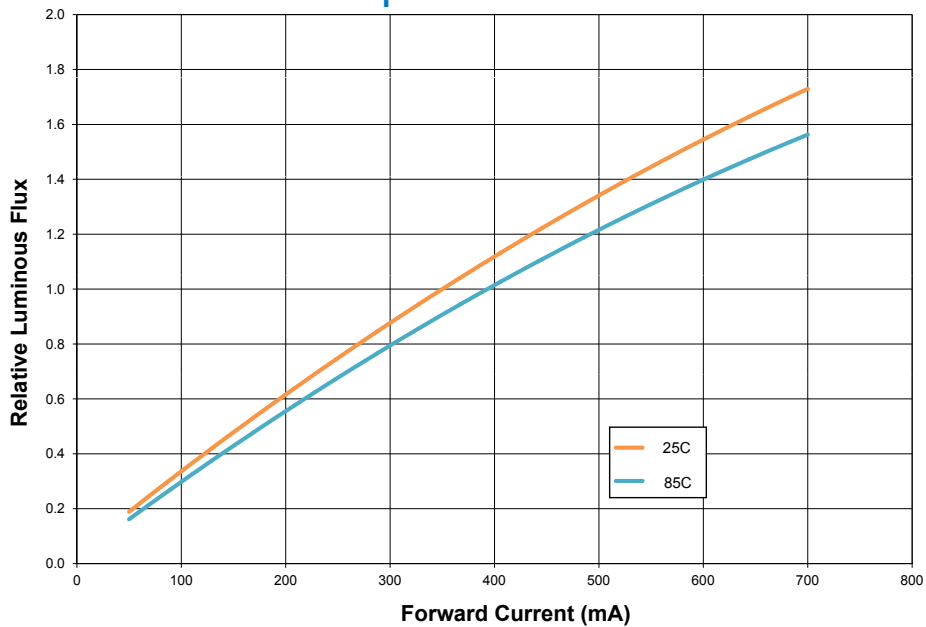

Figure 13. Relative luminous flux vs. forward current for Automotive White (Monopulse).

Typical Relative Luminous Flux vs. Forward Current for PC Amber, Thermal Pad Temperature = 25°C and 85°C

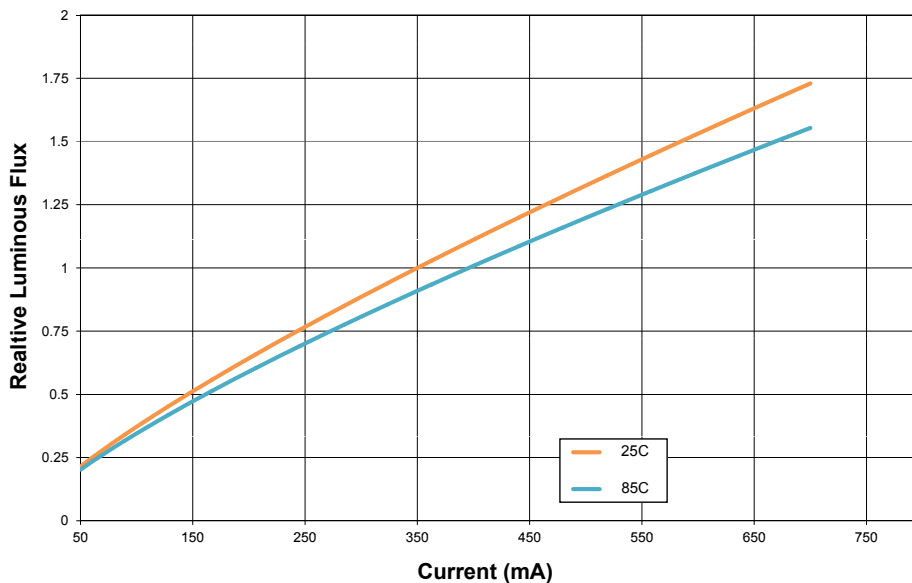

Figure 14. Relative luminous flux vs. forward current for PC Amber (Monopulse).

Relative Luminous Flux vs. Forward Current for Red-Orange and Amber AllnGaP, Thermal Pad Temperature = 25°C

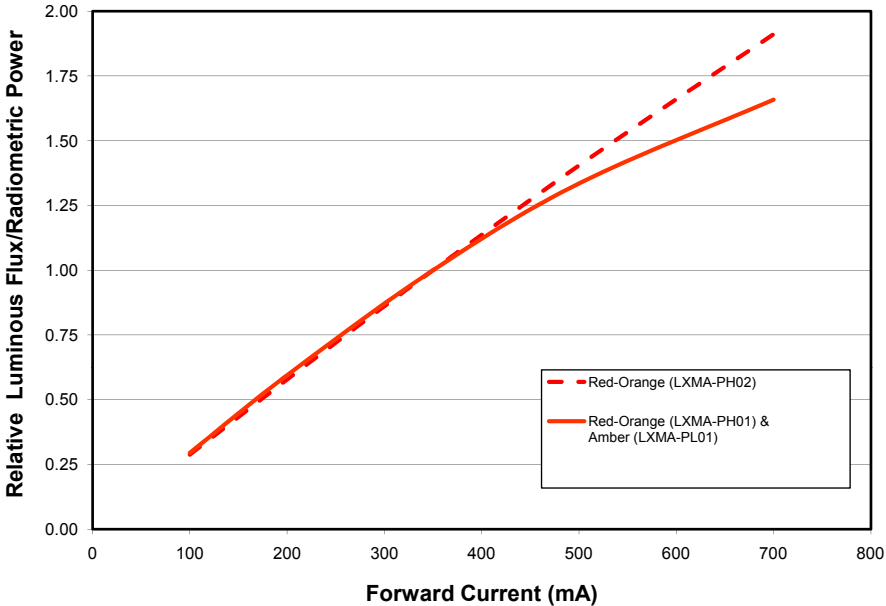

Figure 15. Relative luminous flux vs. forward current for Red-Orange and Amber (Monopulse).

Current Derating Curves

Current Derating Curve for 350 mA Drive Current Automotive White

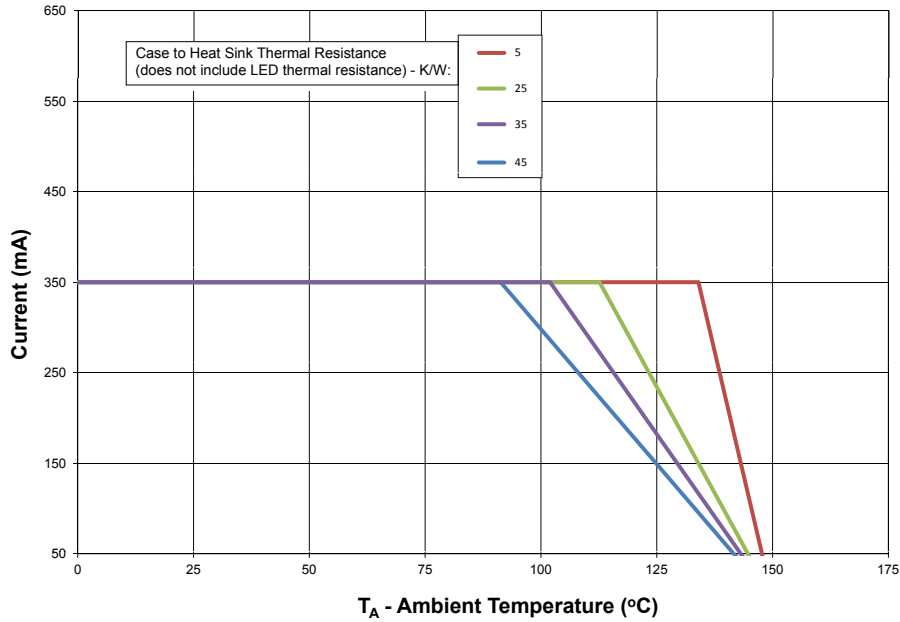

Figure 16. Maximum forward current vs. ambient temperature, based on $T_{JMAX} = 150^{\circ}\text{C}$ for Automotive White.

Current Derating Curve for 350 mA Drive Current PC Amber

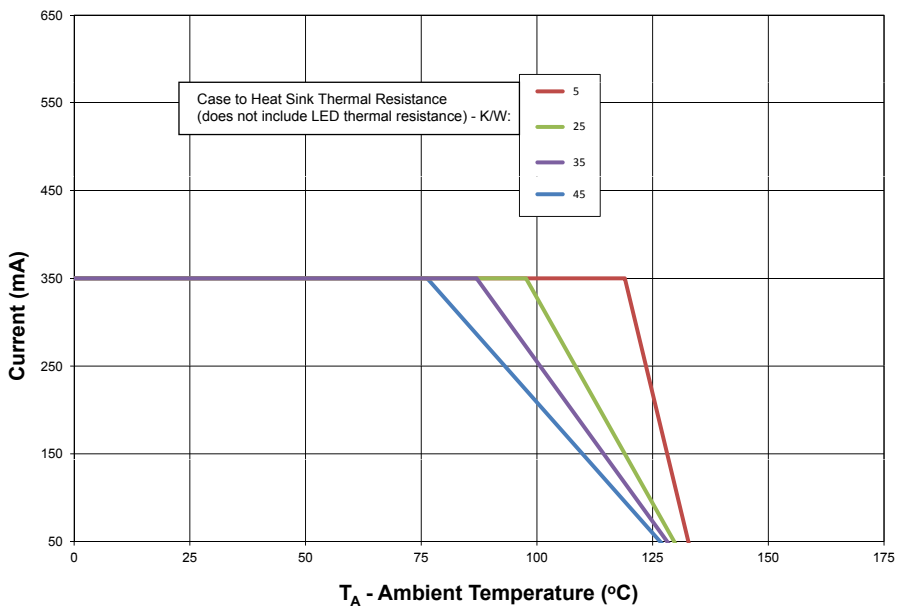

Figure 17. Maximum forward current vs. ambient temperature, based on $T_{JMAX} = 135^{\circ}\text{C}$ for PC Amber.

Current Derating Curve for 350 mA Drive Current Red-Orange and Amber AllnGap

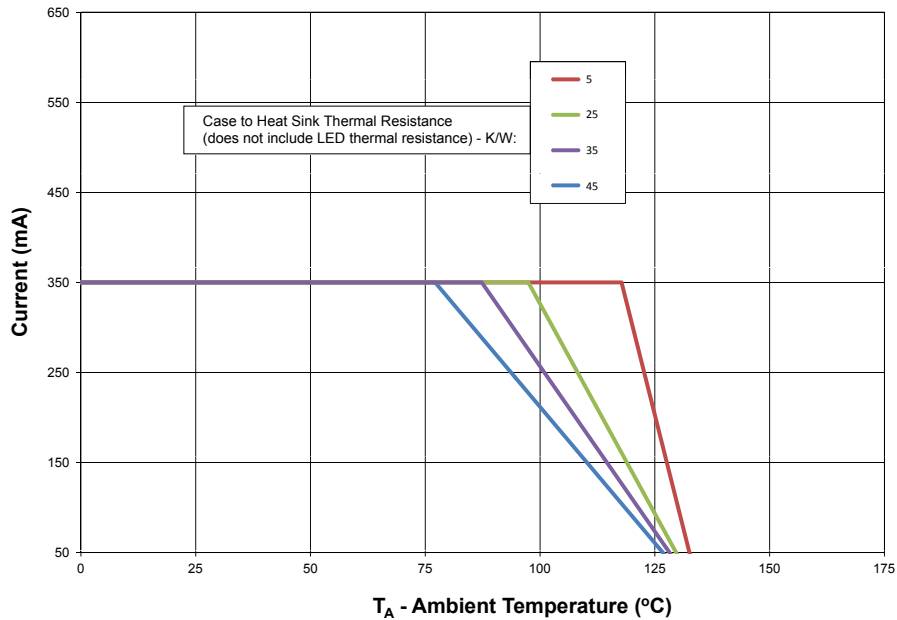

Figure 18. Maximum forward current vs. ambient temperature, based on $T_{JMAX} = 135^{\circ}\text{C}$ for LXMA-PH01 for Red-Orange and Amber.

Current Derating Curve for 350 mA Drive Current Red-Orange AllnGaP

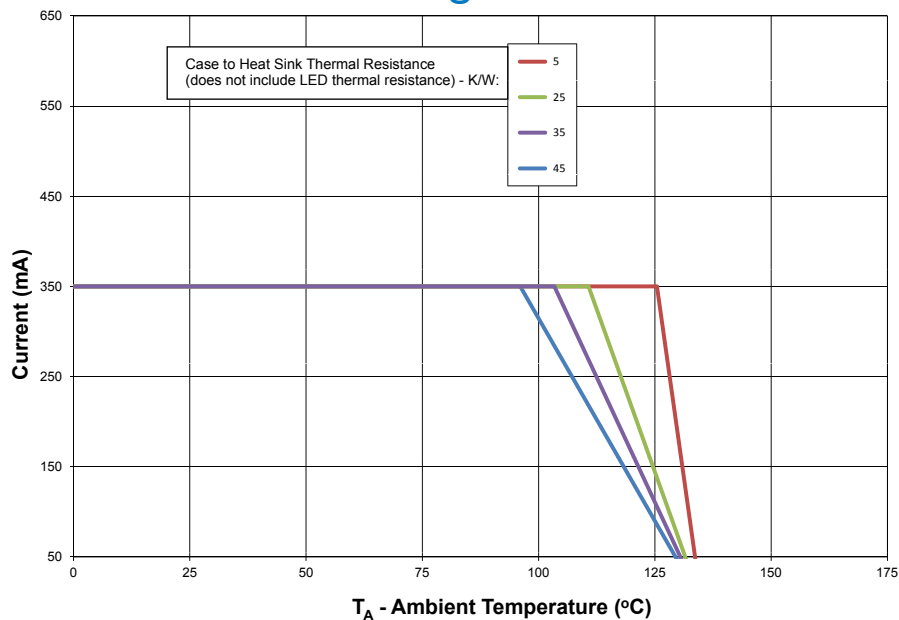

Figure 19. Maximum Forward Current vs. Ambient Temperature, Based on $T_{JMAX} = 135^{\circ}\text{C}$ for Red-Orange LXMA-PH02.

Current Derating Curve for 700 mA Drive Current Automotive White

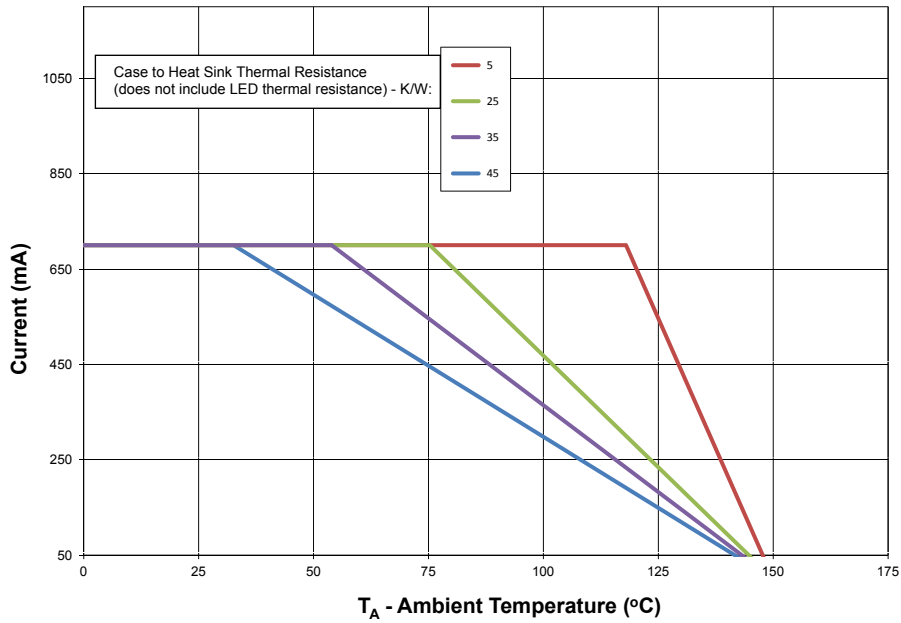

Figure 20. Maximum forward current vs. ambient temperature, based on $T_{JMAX} = 150^{\circ}\text{C}$ for Automotive White.

Current Derating Curve for 700 mA Drive Current PC Amber

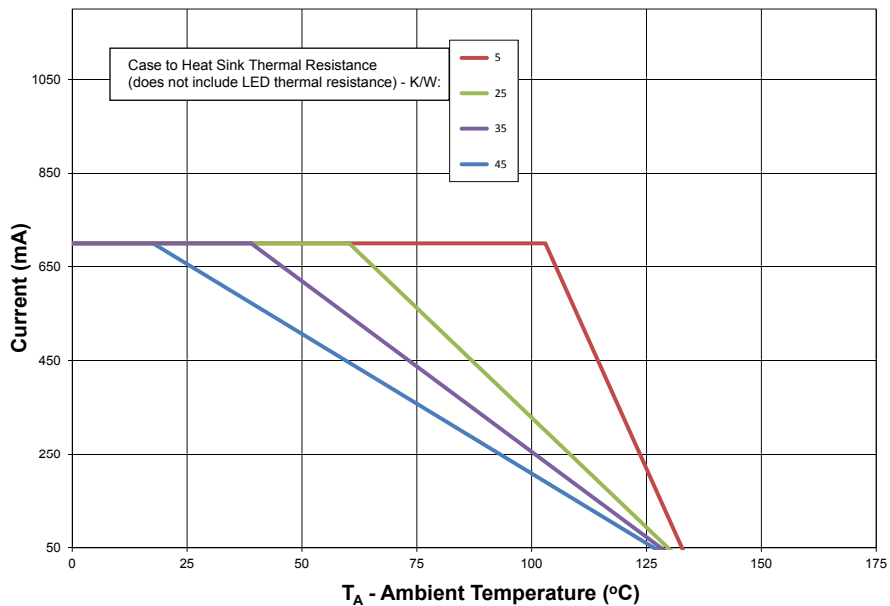

Figure 21. Maximum Forward Current vs. Ambient Temperature, Based on $T_{JMAX} = 135^{\circ}\text{C}$ for PC Amber.

Current Derating Curve for 700 mA Drive Current Red-Orange and Amber AllnGaP

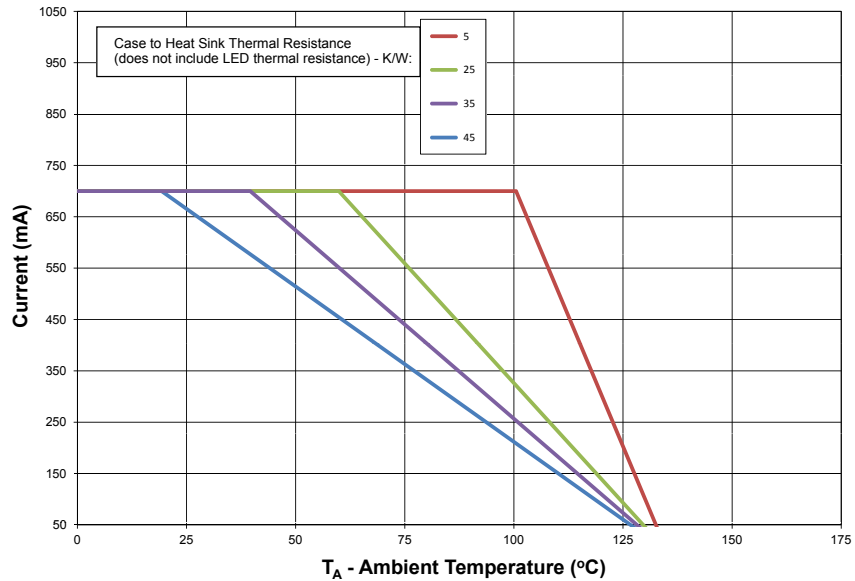

Figure 22. Maximum forward current vs. ambient temperature, based on $T_{JMAX} = 135^{\circ}\text{C}$ for Red-Orange LXMA-PH01 and Amber AllnGaP.

Current Derating Curve for 700 mA Drive Current Red-Orange AllnGaP

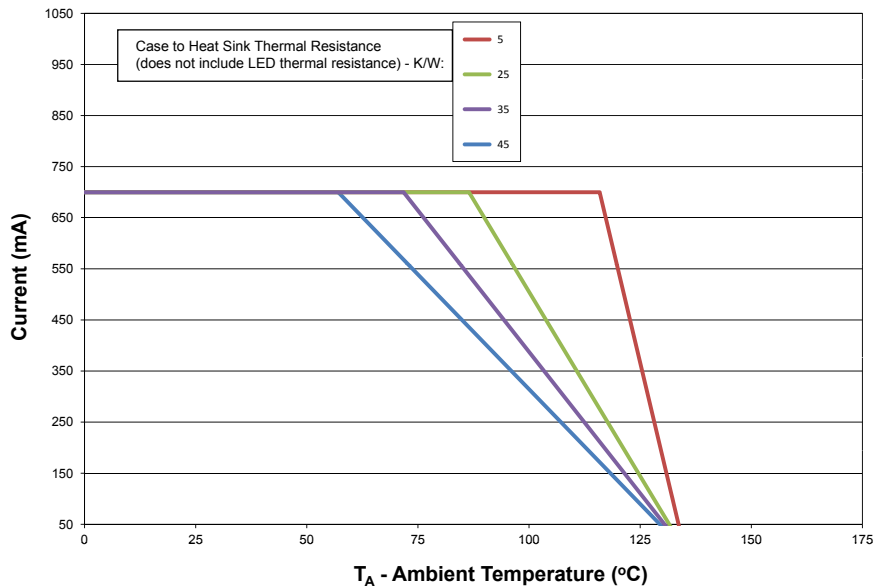

Figure 23. Maximum forward current vs. ambient temperature, based on $T_{JMAX} = 135^{\circ}\text{C}$ for Red-Orange LXMA-PH02 AllnGaP.

Notes for Figures 18-23:

Current derating curves represent constant current operation condition.

Typical Radiation Patterns

Typical Representative Spatial Radiation Pattern for Automotive White Lambertian

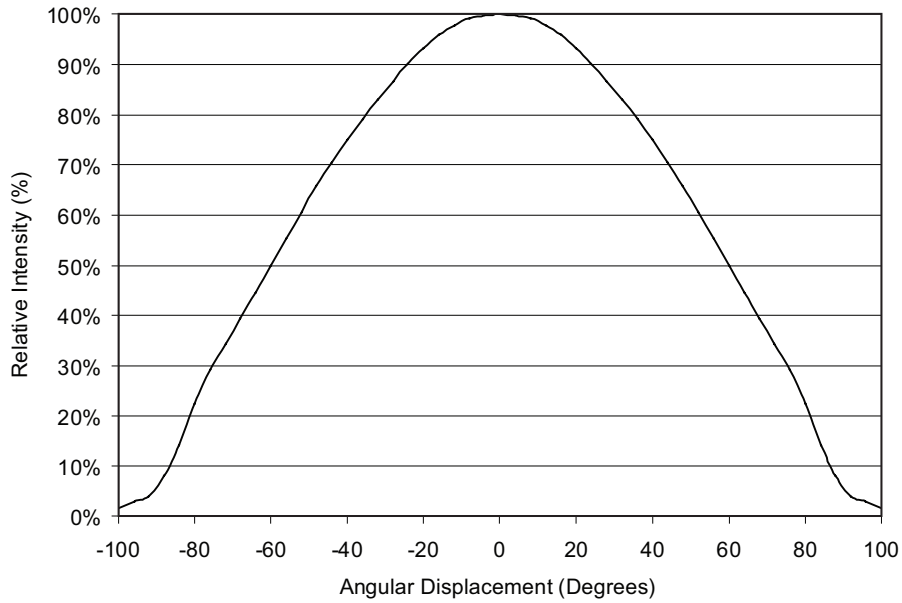

Figure 24: Typical representative spatial radiation pattern for Automotive White Lambertian.

Typical Polar Radiation Pattern for Automotive White Lambertian

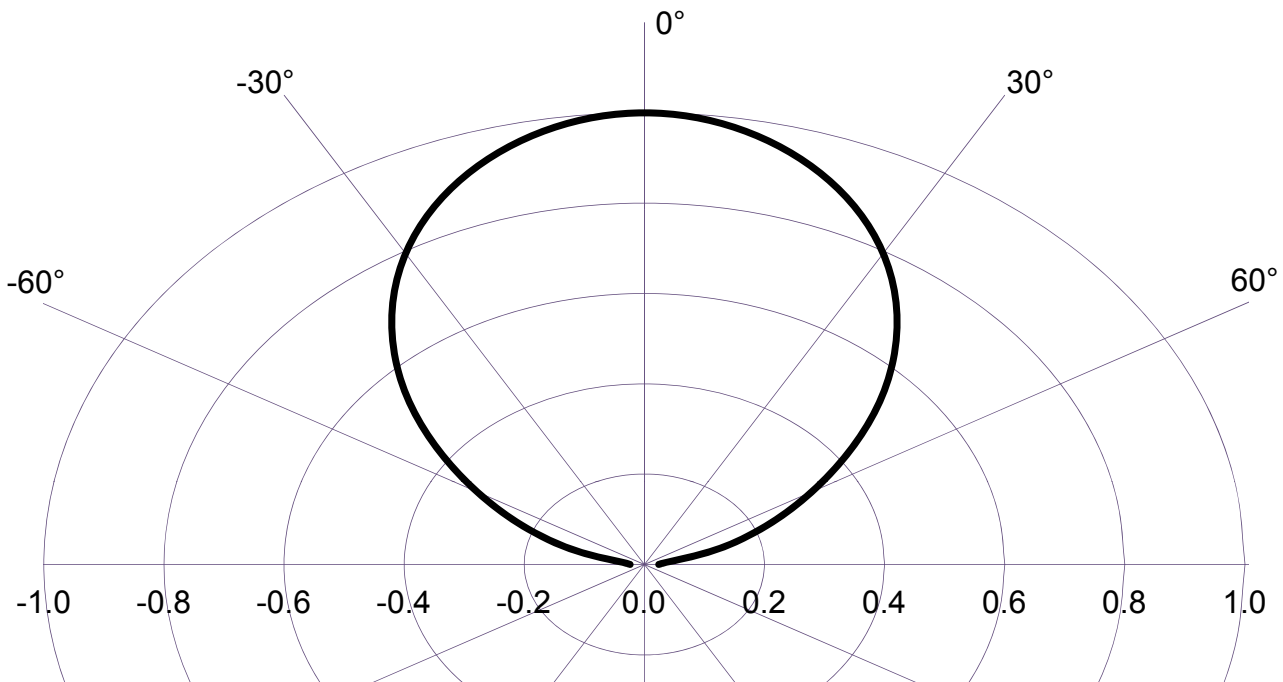

Figure 25: Typical polar radiation pattern for Automotive White Lambertian.

Typical Representative Spatial Radiation Pattern for PC Amber Lambertian

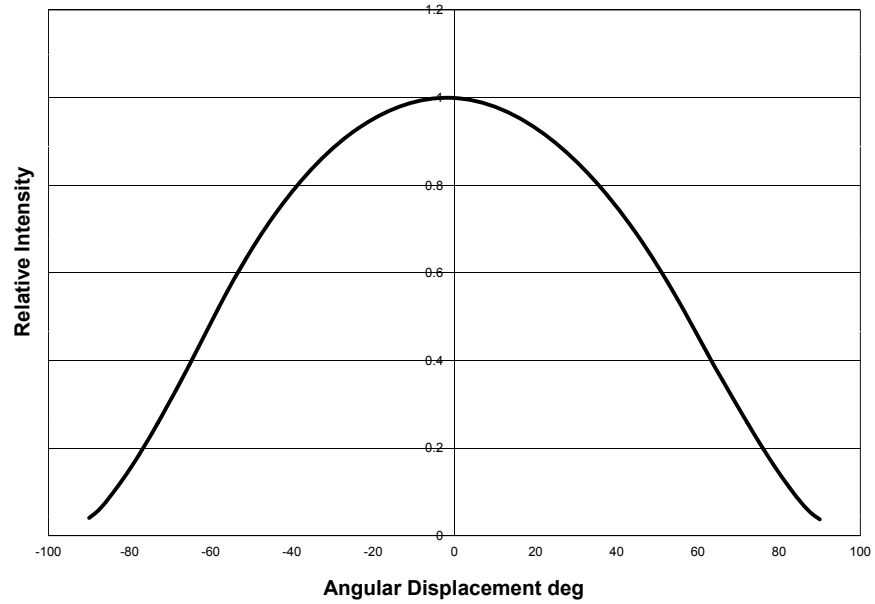

Figure 26: Typical representative spatial radiation pattern for PC Amber lambertian.

Typical Polar Radiation Pattern for PC Amber Lambertian

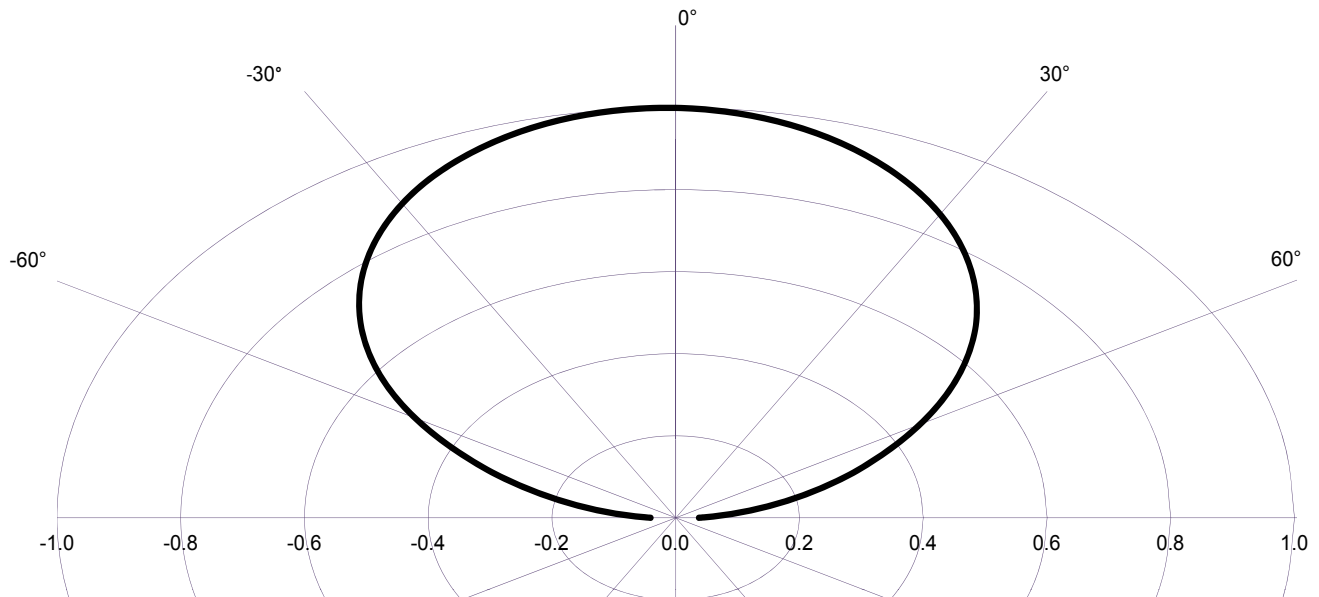

Figure 27: Typical polar radiation pattern for PC Amber lambertian.

Typical Representative Spatial Radiation Pattern for Red-Orange and Amber AllnGaP Lambertian

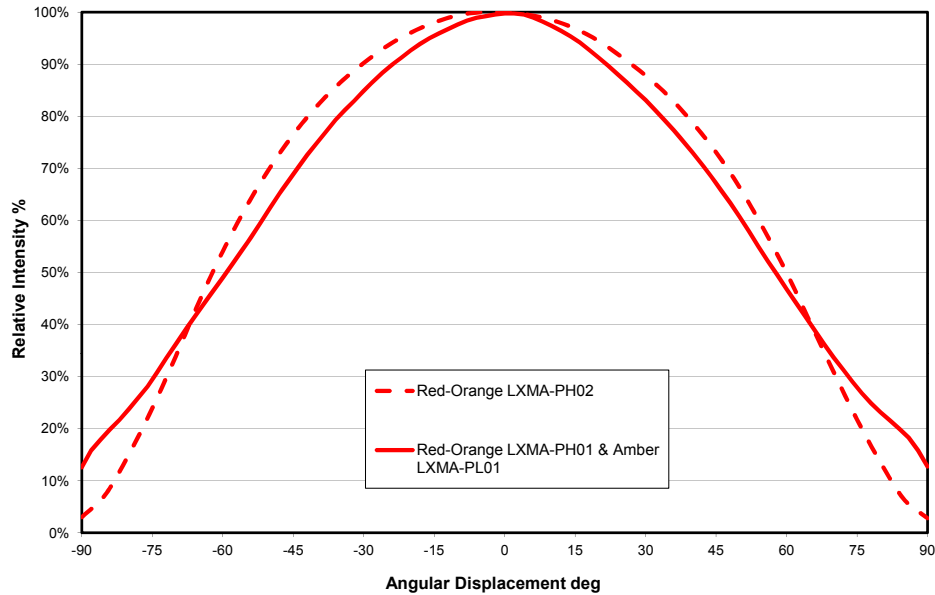

Figure 28: Typical representative spatial radiation pattern for Red-Orange lambertian (LMXA-PH01) and Amber AllnGaP.

Typical Polar Radiation Pattern for Red-Orange and Amber AllnGaP Lambertian

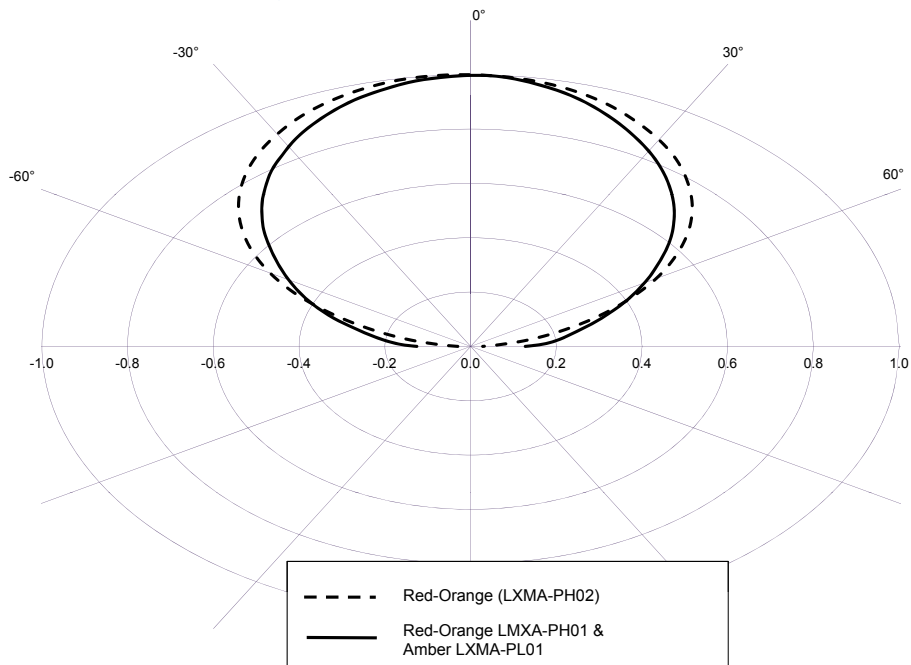

Figure 29: Typical polar radiation pattern for for Red-Orange lambertian (LMXA-PH01) and Amber.

Emitter Pocket Tape Packaging

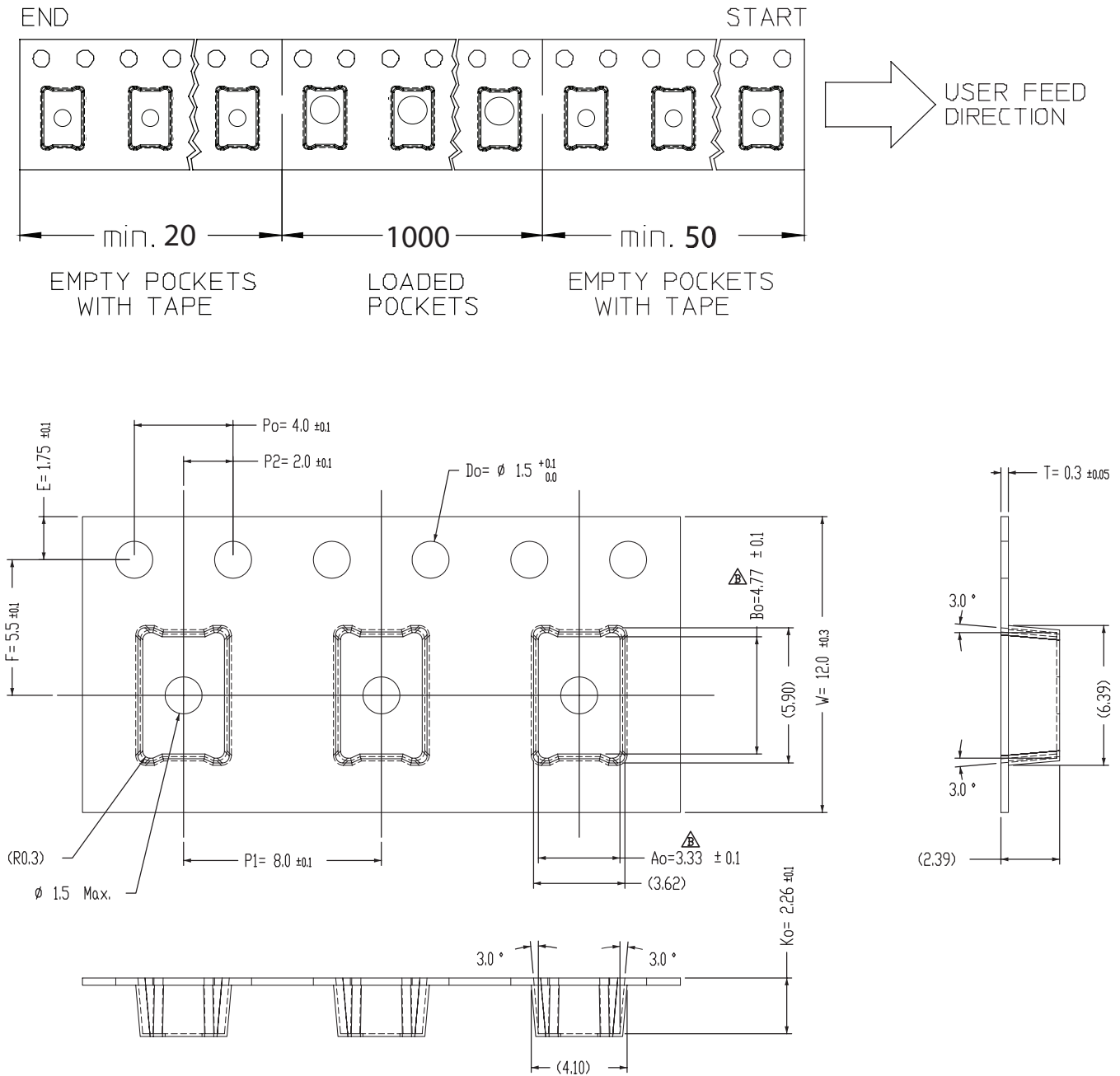

Figure 30. Emitter pocket tape packaging.

Note: SPI may vary from 1000. Please contact Philips Lumileds for more information.

Emitter Reel Packaging

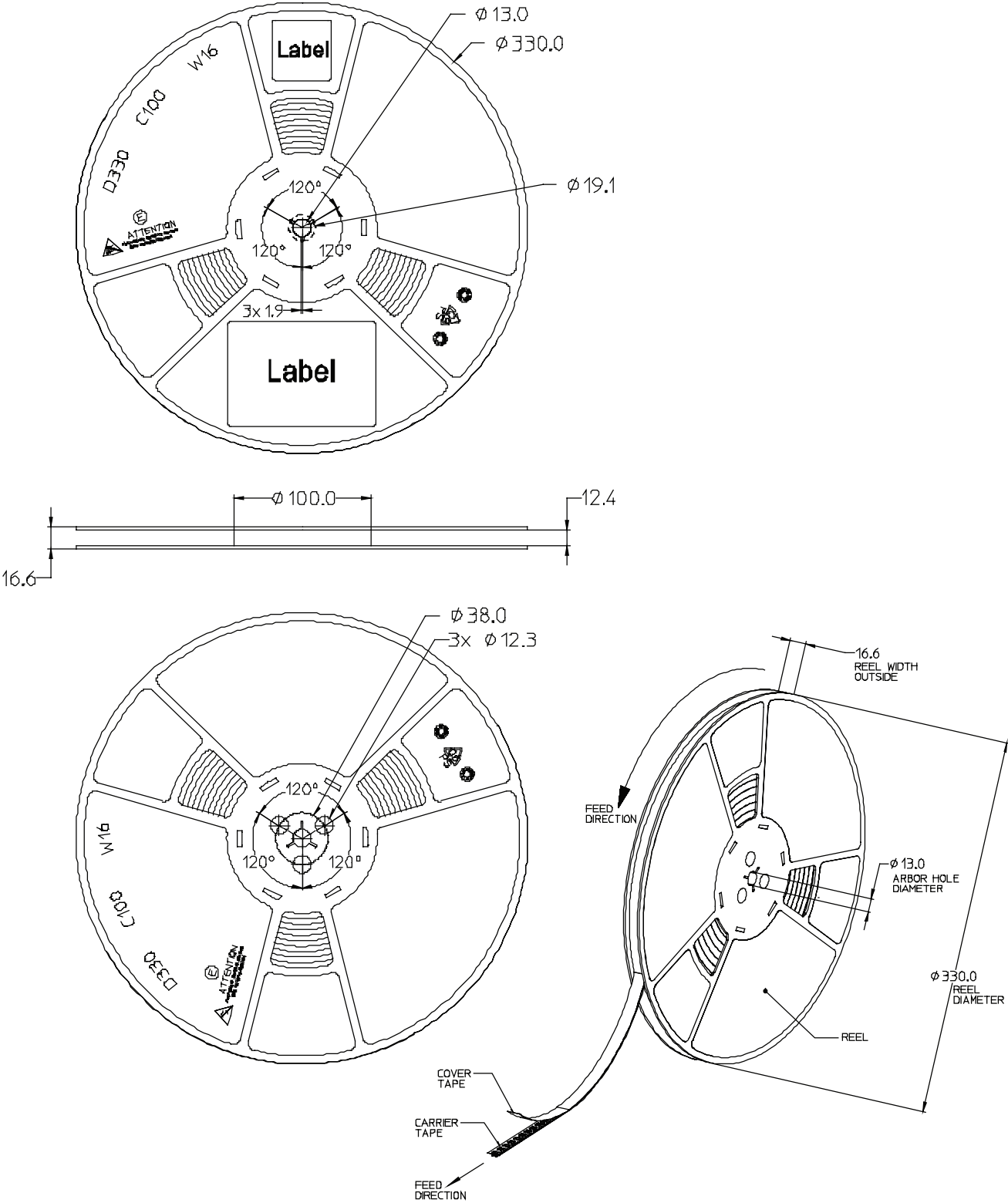

Figure 31. Emitter reel packaging.

Automotive Product Binning and Labeling

Purpose of Product Binning

In the manufacturing of semiconductor products, there is a variation of performance around the average values given in the technical data sheets. For this reason, Philips Lumileds bins the LED components for luminous flux, color and forward voltage (V_f).

Decoding Product Bin Labeling

LUXEON Rebel Emitters are labeled using a three or four digit alphanumeric code (CAT code) depicting the bin values for emitters packaged on a single reel. All emitters packaged within a reel are of the same 3-variable bin combination. Using these codes it is possible to determine optimum mixing and matching of products for consistency in a given application.

Format of Labeling for Emitters

Reels of Red-Orange and Amber Emitters are labeled with a three digit alphanumeric CAT code following the format below.

ABC

A = Flux bin (P, Q, R, S, etc.)

B = Color bin (2, 4, etc.)

C = V_f bin (E, F, G, etc.)

Reels of Automotive White Emitters are labeled with a four digit alphanumeric CAT code following the format below.

ABCD

A = Flux bin (P, Q, R, S, etc.)

B and C = Color bin (WN, W0, WP, WQ, VN, V0 etc.)

D = V_f bin (E, F, G, etc.)

Luminous Flux Bins

Table 8 lists the standard photometric luminous flux bins for LUXEON Rebel emitters.

Although several bins are outlined, product availability in a particular bin varies by production run and by product performance. Not all bins are available in all colors.

Table 8.
Flux Bins - All Colors (except Royal-Blue)

Bin Code	Minimum Photometric Flux (lm)	Maximum Photometric Flux (lm)
E	23.5	30
F	30	40
G	40	50
H	50	60
J	60	70
K	70	80
L	80	90
M	90	100
N	100	110
X	110	120
P	120	130
Y	130	140
Q	140	160

Note for Table 8:

1. Photometric luminous flux bin structure for LUXEON Rebel emitters.

LUXEON Rebel Automotive White Color Bin Structure

Automotive White LUXEON Rebel Emitters for Automotive applications are tested and binned by x,y coordinates.

Table 9.

Bin Code	x	y	Typical CCT (K)	Bin Code	x	y	Typical CCT (K)
A1	0.314792	0.344438	6000	A7	0.364212	0.382878	4300
	0.328823	0.356917			0.381106	0.393747	
	0.329220	0.331331			0.374075	0.365822	
	0.317466	0.320438			0.359401	0.355699	
	0.314792	0.344438			0.364212	0.382878	
A2	0.317466	0.320438	6000	A9	0.381106	0.393747	3950
	0.329220	0.331331			0.396279	0.403508	
	0.329544	0.310495			0.387071	0.373899	
	0.319597	0.301201			0.374075	0.365822	
	0.317466	0.320438			0.381106	0.393747	
A3	0.328823	0.356917	5300				
	0.346904	0.371742					
	0.344443	0.344232					
	0.329220	0.331331					
	0.328823	0.356917					

Note for Table 9:

- I. Philips Lumileds maintains a tester tolerance of ± 0.005 on x,y color coordinates.

Graphical Presentation of LUXEON Rebel Automotive White xy Coordinates

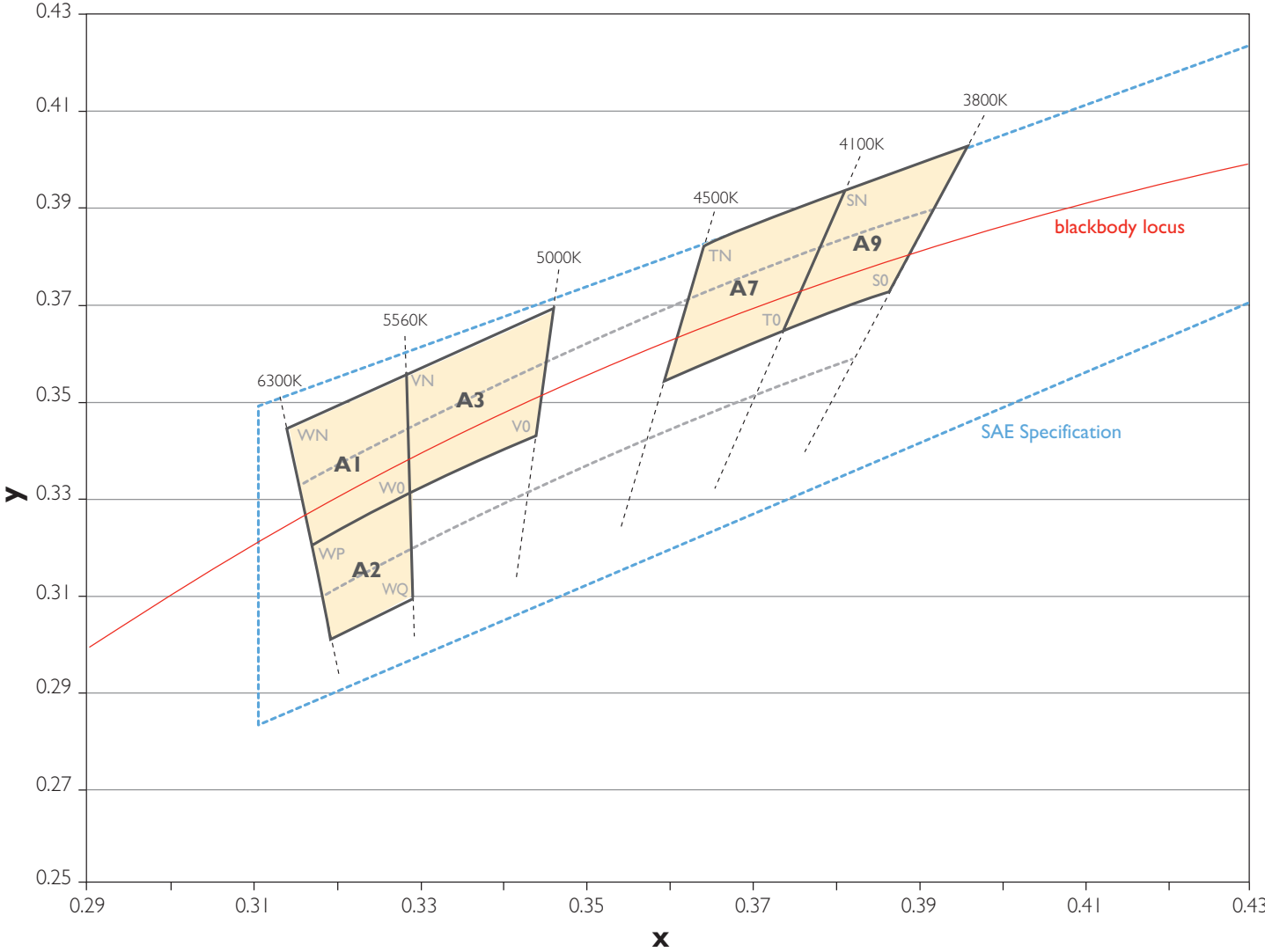

Figure 32. LUXEON Rebel White Automotive color binning structure graphical representation. Coordinates listed in Table 9.

LUXEON Rebel Automotive White Color Binning Structure (A1 ...A10) and White CAT Code Labeling Nomenclature

Table 10.

Automotive Binning Scheme	CAT Code on Product Label
A1	WN,W0
A2	WP,WQ
A3	VN,V0
A7	TN,T0
A9	SN,S0

Philips Lumileds Automotive White Color Bins (A1,A2,A3,A7,A9) are comprised of two white bins from the Philips Lumileds standard 18-Bin white binning structure (i.e.WN,W0, etc.).

A1,A2,A3,A7, and A9 bins are supportable. Binning is program specific, and will be finalized upon mutual agreement and confirmation of supportability by Philips Lumileds.

Philips Lumileds ships product tested and binned according to its standard white binning structure (WN,W0, etc.) in order to provide increased color granularity. Therefore the product label uses the standard 18-Bin white binning CAT code labeling nomenclature. Table 10 may be used to decode the standard white bins on the product label back to the corresponding automotive bins. For more information on the Philips Lumileds standard 18-Bin white binning structure and its CAT code nomenclature please refer to AB21 on www.philipslumileds.com.

LUXEON Rebel PC Amber Color Bin Structure

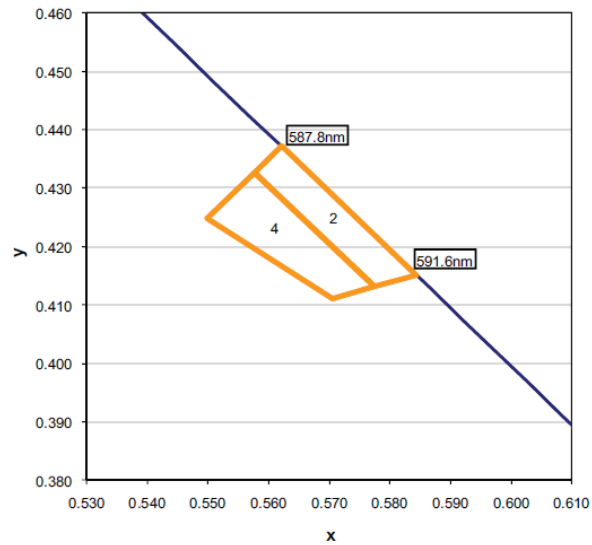

Figure 33: LUXEON Rebel PC Amber Automotive binning structure graphical representation. Coordinates listed in Table II.

LUXEON Rebel PC Amber Color Bin Coordinates

Table II.

LUXEON Rebel PC Amber Bin Coordinates

Color Bin	x	y
2	0.5622	0.4372
	0.5576	0.4326
	0.5775	0.4132
	0.5843	0.4151
4	0.5705	0.4111
	0.5775	0.4132
	0.5576	0.4326
	0.5499	0.4249

Notes for Table II:

1. LUXEON Rebel PC Amber emitters are tested and binned by x, y coordinates.
2. Philips Lumileds maintains a tester tolerance of ± 0.005 on x, y coordinates.
3. Test conditions of 350 mA with current pulse duration of 20ms.

Red-Orange LUXEON Rebel Emitters for automotive applications are tested and binned for dominant wavelength.

Dominant Wavelength Color Bin Structure for LUXEON Rebel Red-Orange AlInGaP

Table 12.

Bin Code	Minimum Dominant Wavelength (nm)	Maximum Dominant Wavelength (nm)
2	613.5	620.5

Amber LUXEON Rebel Emitters for automotive applications are tested and binned for dominant wavelength.

Dominant Wavelength Color Bin Structure for LUXEON Rebel Amber

Table 13.

Bin Code	Minimum Dominant Wavelength (nm)	Maximum Dominant Wavelength (nm)
2	587.0	589.5
4	589.5	592.0

Forward Voltage Bins

Table 14 and 15 lists minimum and maximum V_f bin values per emitter. Although several bins are outlined, product availability in a particular bin varies by production.

Table 14. Forward Voltage Bin Structure for LUXEON Rebel Automotive White, Red-Orange LXMA-PH01, PC Amber and Amber Emitters

Bin Code	Minimum Forward Voltage (V)	Maximum Forward Voltage (V)
A	2.31	2.55
B	2.55	2.79
C	2.79	3.03
D	3.03	3.27
E	3.27	3.51

Table 15. Forward Voltage Bin Structure for LUXEON Rebel Automotive Red-Orange LXMA-PH02 Emitters

V_f bins		
Bin Code	Minimum Forward Voltage (V)	Maximum Forward Voltage (V)
V	1.80	2.00
W	2.00	2.20
X	2.20	2.40
Y	2.40	2.60
Z	2.60	2.80

Company Information

Philips Lumileds is a leading provider of LEDs for everyday lighting applications. The company's records for light output, efficacy and thermal management are direct results of the ongoing commitment to advancing solid-state lighting technology and enabling lighting solutions that are more environmentally friendly, help reduce CO₂ emissions and reduce the need for power plant expansion. Philips Lumileds LUXEON® LEDs are enabling never before possible applications in outdoor lighting, shop lighting, home lighting, consumer electronics, and automotive lighting.

Philips Lumileds is a fully integrated supplier, producing core LED material in all three base colors, (Red, Green, Blue) and white. Philips Lumileds has R&D centers in San Jose, California and in the Netherlands, and production capabilities in San Jose, Singapore and Penang, Malaysia. Founded in 1999, Philips Lumileds is the high flux LED technology leader and is dedicated to bridging the gap between solid-state technology and the lighting world. More information about the company's LUXEON LED products and solid-state lighting technologies can be found at www.philipslumileds.com.

©2012 Philips Lumileds Lighting Company. All rights reserved.
Product specifications are subject to change without notice.
LUXEON is a registered trademark of the Philips Lumileds
Lighting Company in the United States and other countries.

PHILIPS
LUMILEDS

www.philipslumileds.com
www.philipslumileds.cn.com